

Dimensions in "mm"

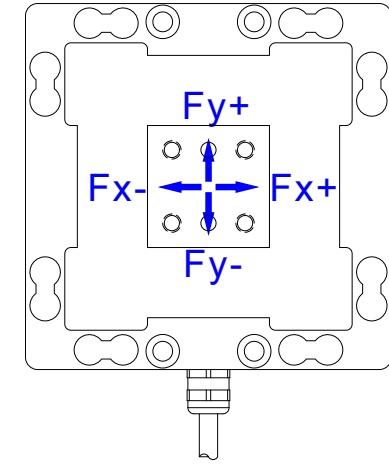

Force direction



Wiring Diagram/接线图

X-axis

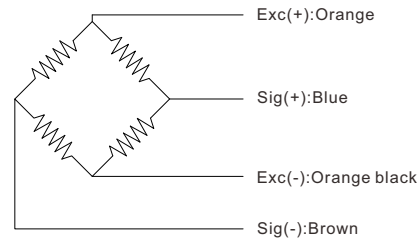

Y-axis

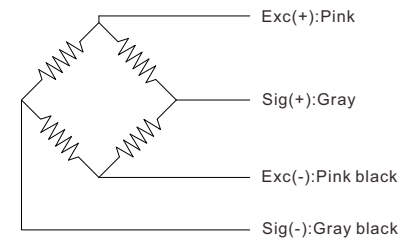

Z-axis

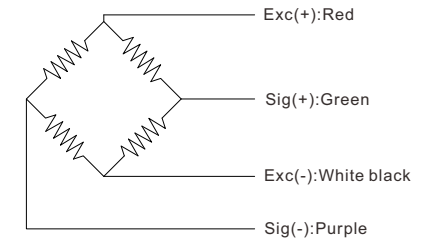

Cable outlet

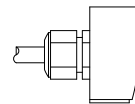

Standard(With direct cable outlet)

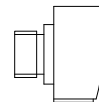

Optional (Disconnectable cable with mating connector)

--- Specifications / 规格参数 ---

Capacity/量程	200/300/500/1k/2k/3k/5k N (Refer to ordering code)		
Rated Output 额定输出	1.0 mV/V	Crosstalk 串扰	<3% of F.S.
Excitation 激励电压	3~15V	Operating Temp. 工作温度范围	-10...+60°C
Zero Balance 零点输出	±0.05mV/V	Temp. Shift Zero 零点温度漂移	±0.03% of R.O./°C
Nonlinearity 非线性	±0.3% of R.O.	Temp. Shift Span 灵敏度温度漂移	±0.02% of R.O./°C
Hysteresis 滞后	±0.3% of R.O.	Input Resistance 输入阻抗	700±100Ω
Nonrepeatability 非重复性	±0.1% of R.O.	Output Resistance 输出阻抗	700±100Ω
Creep(5min) 蠕变(5min)	±0.05% of R.O.	Insulation Resistance 绝缘阻抗	>2000MΩ(50V)
Safe Overload 安全过载	150% of F.S.	Ingress Protection 防护等级	IP65
Ultimate Overload 极限过载	200% of F.S.	Material of Element 弹性体材料	Refer to ordering code
Cable 导线	Ø6*3000mm 12-pin shielded cable(Longer cable available) Ø6*3000mm 12芯屏蔽线		
R.O.=Rated Output/额定输出 F.S.=Full Scale/满量程			

Ordering code

Part No.	Capacity		Material	
	Fx=Fy	Fz		
F3F-200N	200N	200N	Aluminum alloy	
F3F-200-200-300		300N		
F3F-300N	300N	300N		
F3F-300-300-500		500N		
F3F-500N	500N	500N		
F3F-500-500-1k		1kN		
F3F-1kN	1kN	1kN		
F3F-1k-1k-2k		2kN		
F3F-2kN	2kN	2kN		Stainless steel
F3F-2k-2k-3k		3kN		
F3F-3kN	3kN	3kN		
F3F-3k-3k-5k		5kN		
F3F-5kN		5kN		

■ Consult us for disconnectable connector or longer cable

3-Channel load cell amplifier LC3A

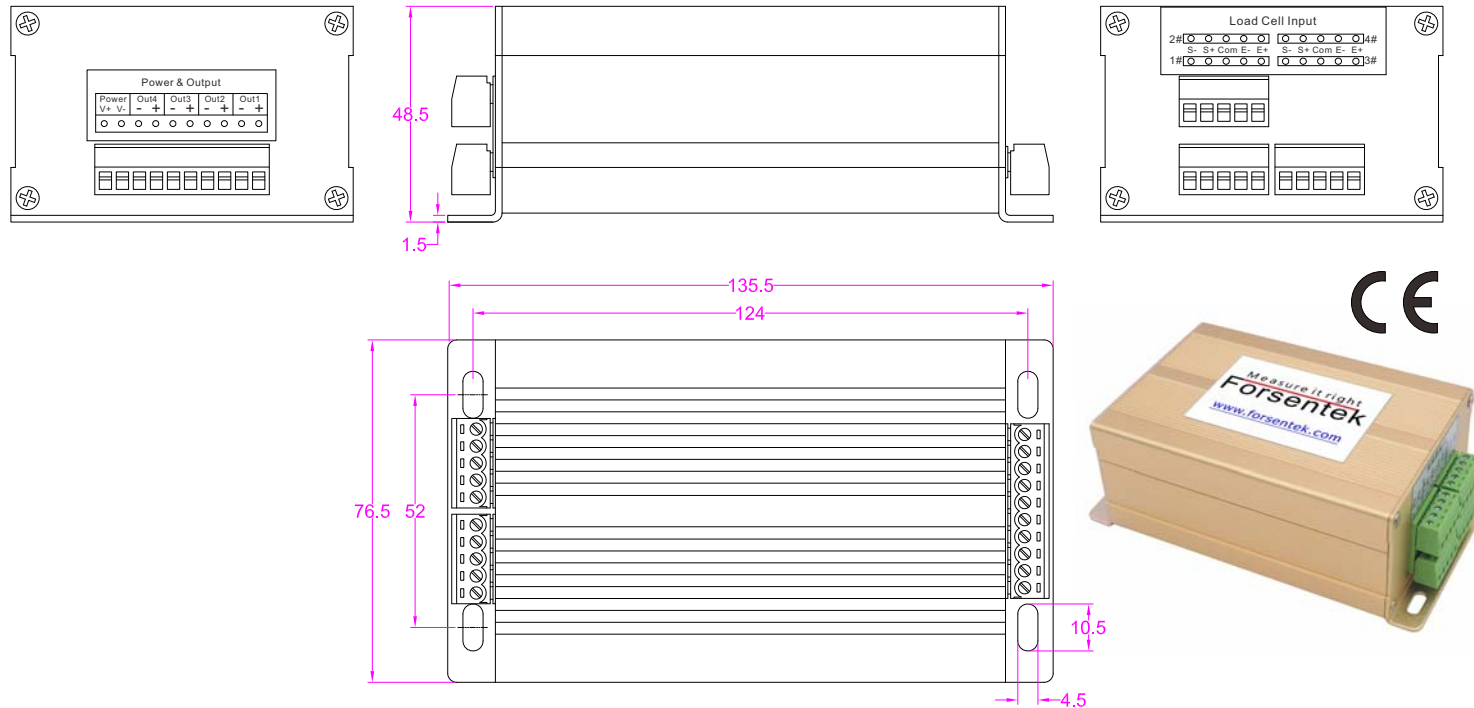

Ordering Code			
For compression only (Or tension only)		For tension and compression (Or clockwise and CCW)	
24V Power supply	12V Power supply	24V Power supply	12V Power supply
LC3A(0-3.3V)-24V	LC3A(0-3.3V)-12V	LC3A(0-1.5-3V)-24V	LC3A(0-1.5-3V)-12V
LC3A(0-5V)-24V	LC3A(0-5V)-12V	LC3A(0-2.5-5V)-24V	LC3A(0-2.5-5V)-12V
LC3A(0-10V)-24V	LC3A(0-10V)-12V	LC3A(0-5-10V)-24V	LC3A(0-5-10V)-12V
LC3A(0-20mA)-24V	LC3A(0-20mA)-12V	LC3A(-5-5V)-24V	LC3A(-5-5V)-12V
LC3A(4-20mA)-24V	LC3A(4-20mA)-12V	LC3A(-10-10V)-24V	LC3A(-10-10V)-12V
/	/	LC3A(4-12-20mA)-24V	LC3A(4-12-20mA)-12V
Consult us for other outputs			

Function / 功能	Turn mV signal into V or mA signal 将mV信号放大成V或mA信号
Accuracy / 精度	0.15%
Power supply / 供电电压	24V DC or 12V DC
Excitation for sensor / 传感器激励电压	5V DC
Input signal range / 输入信号范围	0.6~3.0mV/V
Working Temp. / 工作温度	-10...+60°C
Material of enclosure / 外壳材料	Aluminum alloy/铝合金
Ingress protection / 防护等级	IP40

• Subject to change without notice / 如有更改,不另行通知

Wiring example between F3F and amplifier LC3A

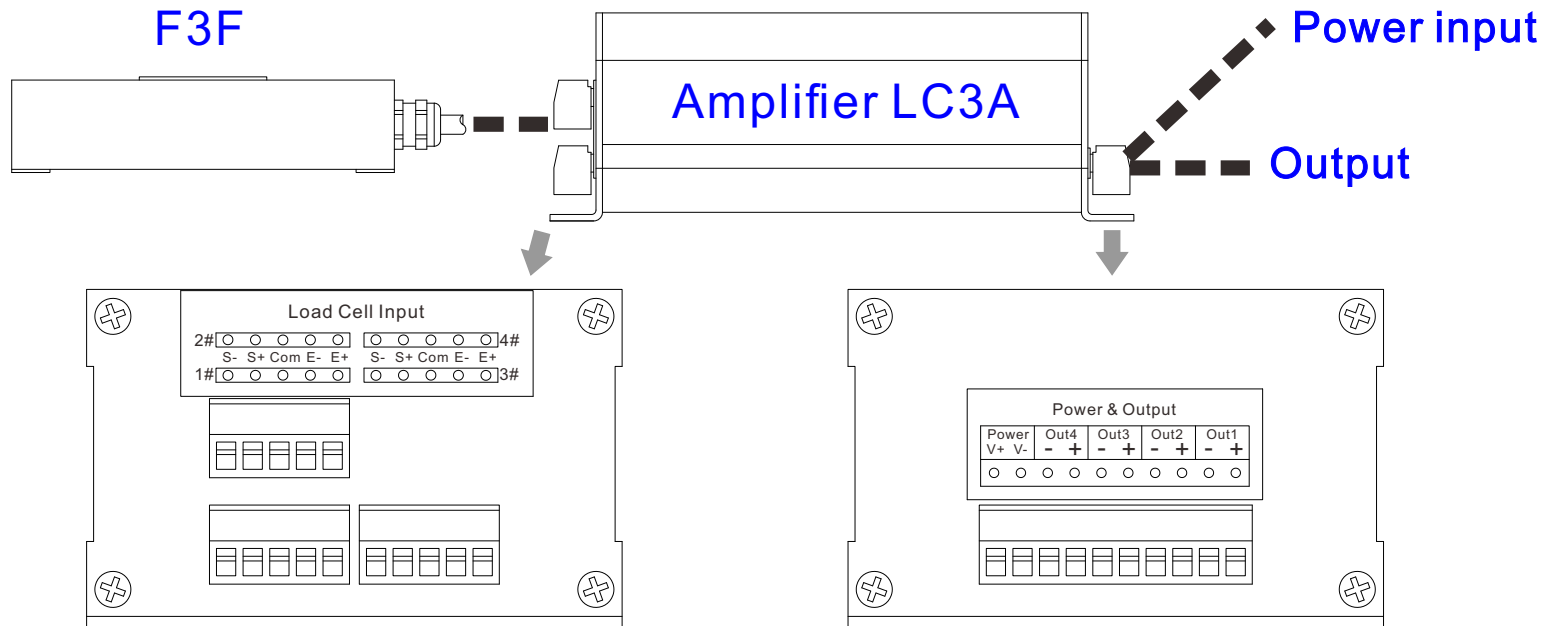

Wiring code

1# terminal connects with Fx channel			
E+	Orange	E-	Orange black
S+	Blue	S-	Brown
2# terminal connects with Fy channel			
E+	Pink	E-	Pink black
S+	Gray	S-	Gray black
3# terminal connects with Fz channel			
E+	Red	E-	White black
S+	Green	S-	Purple

Power			
V+	Power+	V-	Power-
Out1 @ Fx output			
+	Output+	-	Output-
Out2 @ Fy output			
+	Output+	-	Output-
Out3 @ Fz output			
+	Output+	-	Output-

• Subject to change without notice / 如有更改,不另行通知

Calibration instructions of F3F and LC3A

Before operation, clients need to prepare:

- 1-Power supply for LC3A
- 2-4 x 2-core cables for power input and signal output
- 3-Multimeter to measure the output signal from LC3A
- 4-Reference load and necessary tools for calibration
- 5-Screw drivers to open the cover plate of LC3A and adjust the potentiometers during calibration

1-Wiring(Refer to P-4/5)

2-Open the top cover plate of LC3A,you'll see right view: 

3-Calibration of Fx channel

- 3.1-Measuring the output signal from Out1 of LC3A using a multimeter.
- 3.2-Applying 0 load to Fx direction,adjust potentiometer "1# Zero" to get desired output.
- 3.3-Applying reference load to Fx direction,adjust potentiometer "1# Gain" to get desired output.
- 3.4-Repeat step 3.2 and 3.3 for 2-3 times to get better result.

4-Calibration of Fy channel

- 4.1-Measuring the output signal from Out2 of LC3A using a multimeter.
- 4.2-Applying 0 load to Fy direction,adjust potentiometer "2# Zero" to get desired output.
- 4.3-Applying reference load to Fy direction,adjust potentiometer "2# Gain" to get desired output.
- 4.4-Repeat step 4.2 and 4.3 for 2-3 times to get better result.

5-Calibration of Fz channel

- 5.1-Measuring the output signal from Out3 of LC3A using a multimeter.
- 5.2-Applying 0 load to Fz direction,adjust potentiometer "3# Zero" to get desired output.
- 5.3-Applying reference load to Fz direction,adjust potentiometer "3# Gain" to get desired output.
- 5.4-Repeat step 5.2 and 5.3 for 2-3 times to get better result.

6-Install the top cover plate of LC3A

